

POOLEX
O'SPA

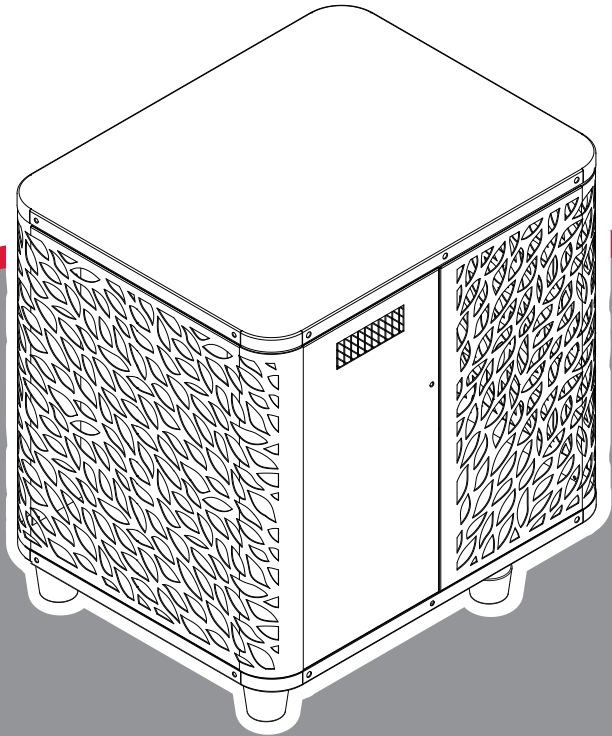

Installation and user manual



Acknowledgements

Dear customer,

Thank you for your purchase and your trust in our products.

Our products are the result of years of research in the design and manufacture of heat pumps for pools. Our goal is to deliver high-quality products with exceptional performance.

We took great care to put together this manual so you can get the most out of your Poolex heat pump.

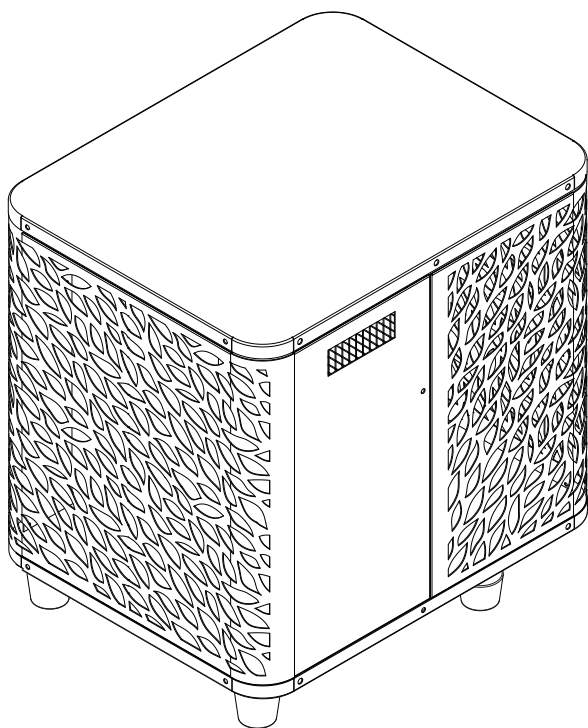



PLEASE READ CAREFULLY



These installation instructions form an integral part of the product.
They must be provided to the installer and kept in a safe place by the user.

If you lose this manual, please visit our website:

www.poolex.fr

The indications and warnings contained in this manual should be carefully read and understood as they provide important information regarding the safe handling and operation of the heat pump. Keep this manual handy for future reference.

Installation must be performed by a qualified professional in accordance with regulations in force and the manufacturer's instructions. Errors made during installation can cause physical injuries to people and animals, as well as mechanical damage for which the manufacturer shall not be held liable.

After unpacking the heat pump, please check the contents for any signs of damage.

Before plugging in the heat pump, ensure that the instructions provided in this manual are compatible with the actual installation conditions and do not exceed the maximum authorised limits for the product in question.

In the event of a defect and/or malfunction of the heat pump, electrical power must be shut off and no attempts to repair the fault should be made.

Repairs must be carried out by an authorised technician using original spare parts. Non-compliance with the aforementioned clauses can negatively impact the safe operation of the heat pump.

In order to guarantee the efficiency and ensure the proper functioning of the heat pump, it must be regularly maintained in accordance with the instructions provided.

In the event the heat pump is sold or transferred to a third party, please ensure that all technical documentation is given to the new owner alongside the equipment.

This heat pump has been designed to only heat the water of a swimming pool. Any other use is considered inappropriate, incorrect and potentially dangerous.

All contractual and extra-contractual liability on the part of the manufacturer / distributor shall be considered null and void in the event of damage caused by errors in installation or operation, or due to non-compliance with the instructions provided in this manual, or the standards in force for the installation of equipment discussed in this document.

Contents

1.	General information	4
1.1	General terms and conditions of delivery	4
1.2	Safety instructions	4
1.3	Water treatment	5
1.4	Operating limits	6
2.	Description	7
2.1	Package contents	7
2.2	General characteristics	7
2.3	Technical characteristics	8
2.4	Product dimensions	9
2.5	Exploded view	10
3.	Installation & operation	11
3.1	Location	11
3.2	Installation diagram	12
3.3	Hydraulic connections	12
3.4	Electrical connections	12
3.5	Operation	13
4.	Use	14
4.1	Control panel	14
4.2	Heating / Cooling / Automatic mode	14
4.3	Functions overview	15
4.4	Heat pump operating mode selector	15
4.5	Using the hot tub heater control relay	16
4.6	Using the hot tub circulation pump control relay	17
4.7	Downloading & installing the application	18
4.8	Setting up the application	19
4.9	Pairing the heat pump	21
4.10	Use	22
4.11	Status values	24
4.12	Advanced settings	25
5.	Maintenance and servicing	26
5.1	Maintenance, servicing and winterizing	26
6.	Repairs	27
6.1	Breakdown and faults	27
7.	Warranty	28
7.1	General warranty conditions	28
A.	Tenders	A
A.1	<i>Wiring diagrams</i>	A

1. General information

1.1 General terms and conditions of delivery

All products and packaging, even those delivered carriage paid, travel at the risk of the recipient.

Persons responsible for accepting delivery of the device must perform a visual inspection to make a note of any damage that may have occurred during transportation (refrigeration circuit, casing, electric box, frame). Any damage occurring during transportation must be noted by the recipient on the delivery receipt of the carrier, and confirmed by registered post sent to the carrier within 48 hours.

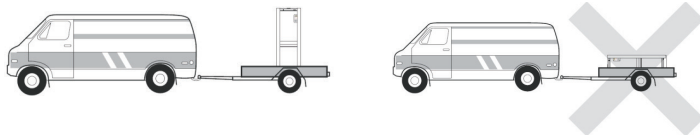

The device must be stored and transported upright at all times, on a pallet, and in its original packaging. If the device has been transported in a horizontal position, please wait at least 24 hours prior to connecting it.

1.2 Safety instructions



WARNING: Please read carefully all safety instructions before using the device. As the instructions noted in this document are essential to your safety, please respect them carefully.

Installation and maintenance

Only a qualified person may undertake installation, start-up, servicing and repairs, in compliance with current standards.

Before operating or undertaking any work on the device (installation, start-up, use, servicing), the person responsible must be aware of all the instructions in the heat pump's installation manual as well as the technical specifications.

Under no circumstances install the equipment close to a source of heat, combustible materials or a building's air intake.

If installation is not in a location with restricted access, a heat pump protective grille must be fitted.

To avoid severe burns, do not walk on pipework during installation, repairs or maintenance.

To avoid severe burns, prior to any work on the refrigerant system, turn off the heat pump and wait several minutes before placing temperature and pressure sensors.

Check the refrigerant level when servicing the heat pump.

Check that the high and low pressure switches are correctly connected to the refrigerant system and that they turn off the electrical circuit if tripped during the equipment's annual leakage inspection.

Check that there is no trace of corrosion or oil stains around the refrigerant components.

1. General information

When in use

Do not touch the vent during operation due to the risk of serious injury.

Do not leave the heat pump within reach of children due to the risk of injury caused by the heat exchanger fins.

Never start the equipment if there is no water in the pool or if the circulating pump is stopped.

Check the water flow rate every month and clean the filter if necessary.

When cleaning

1. Switch off the power supply to the device.
2. Close the water inlet and outlet valves.
3. Do not place anything in the openings of the water or air inlets/outlets.
4. Do not spray the appliance with excessive amounts of water.

During repairs

Carry out work on the refrigerant system in accordance with current safety regulations.

Brazing should be performed by a qualified welder.

When replacing a defective refrigerant component, use only parts certified by our technical department.

When replacing pipework, only copper pipes conforming to Standard NF EN12735-1 may be used for repairs.

When pressure-testing to detect leaks:

- Use dehydrated nitrogen or a mixture of nitrogen and refrigerant.
- To avoid the risks of fire or explosion, never use oxygen or dry air.

The low and high side test pressure must not exceed 42 bar.

1.3 Water treatment

Poolex heat pumps for swimming pools can be used with all types of water treatment systems.

Nevertheless, it is essential that the treatment system (chlorine, pH, bromine and/or salt chlorinator metering pumps) is installed after the heat pump in the hydraulic circuit.

To avoid any deterioration to the heat pump, the water's pH must be maintained between 6.9 and 8.0.

1. General information

1.4 Operating limits

Your O'SPA heat pump's performance is at its optimal when outside temperature is between 10°C and 43°C.

When outside temperature is between -7°C and 10°C, the O'SPA heat pump is useful to maintain the temperature within the hot tub. However, it is not suitable to heat up your hot tub alone when outside temperature is below 10°C. As such, it is recommended to use it with the SPA heater control relay (see paragraph 4.5) during the cold season.

Your hot tub must be correctly insulated to enable the O'SPA heat pump to function in an optimal way.

- The tub must be insulated.
- The piping must be insulated.
- The hot tub must be equipped with an insulating cover.

2. Description

2.1 Package contents

At reception, please check that your package contains the following:

- A Poolex O'SPA heat pump
- 2x 1" (inch) to 32/38 mm hydraulic connections
- 2x stainless steel hose clamps
- 1x spa heater control relay
- 4x anti-vibration pads (directly mounted on the heat pump)
- This installation and operation manual

2.2 General characteristics

A Poolex heat pump has the following features:

- ◆ High performance with up to 80% energy savings compared to a conventional heating system.
- ◆ Clean, efficient and environmentally friendly R32 refrigerant.
- ◆ Reliable high output leading brand compressor.
- ◆ Wide hydrophilic aluminum evaporator for use at low temperatures.
- ◆ User-friendly intuitive control panel.
- ◆ Heavy duty shell, anti-UV treated and easy to maintain.
- ◆ CE certification.
- ◆ Designed to be silent.

2. Description

2.3 Technical characteristics

		O'Spa 30	O'Spa 50
Air ⁽¹⁾ 26°C Water ⁽²⁾ 26°C	Heating power (kW)	3.0	5.02
	Consumption (kW)	0.58	0.97
	COP (Coeff. Of performance)	5.15	5.2
Air ⁽¹⁾ 15°C Water ⁽²⁾ 26°C	Heating power (kW)	2.0	4.03
	Consumption (kW)	0.5	1
	COP (Coeff. Of performance)	4	4.05
Air ⁽¹⁾ 5°C Water ⁽²⁾ 38°C	Heating capacity (kW)	1.35	2.36
	Consumption (kW)	0.67	0.89
	COP (Coeff. Of performance)	2.06	2.65
Air ⁽¹⁾ 15°C Water ⁽²⁾ 38°C	Heating capacity (kW)	1.80	3.3
	Consumption (kW)	0.65	1.1
	COP (Coeff. Of performance)	2.77	3
Air ⁽¹⁾ 35°C Water ⁽²⁾ 27°C	Cooling capacity (kW)	1.46	2.99
	Consumption (kW)	0.53	1
	EER	2.75	2.99
Power supply	Single phase 220-240V ~ 50Hz		
Maximum power (kW)	0.7	1.35	
Maximum current (A)	3.11	5.99	
Heating temperature range	10°C~ 40°C		
Operating range	-7°C~ 43°C		
Unit dimensions L x W x H (mm)	440*380*423	440*380*423	
Unit weight (kg)	26	32	
Sound pressure level à 10m (dBA) ⁽³⁾	< 30	< 32	
Hydraulic connections (mm)	PVC 32/38 mm		
Heat exchanger	PVC tank and titanium heating coil		
Min. water flow rate (m³/h)	1.30	2.16	
Compressor type	Rotary		
Refrigerant	R32		
Protection rating	IPX4		
Load loss (mCE)	1.2	1.2	
Control panel	Digital-display control panel		
Mode	Heating		

The technical specifications of our heat pumps are provided for information purposes only. We reserve the right to make changes without prior notice.

¹ Ambient air temperature

² Initial water temperature

³ Noise level at a distance of 10 m in accordance with international standards EN ISO 3741 and EN ISO 354

2. Description

2.4 Product dimensions

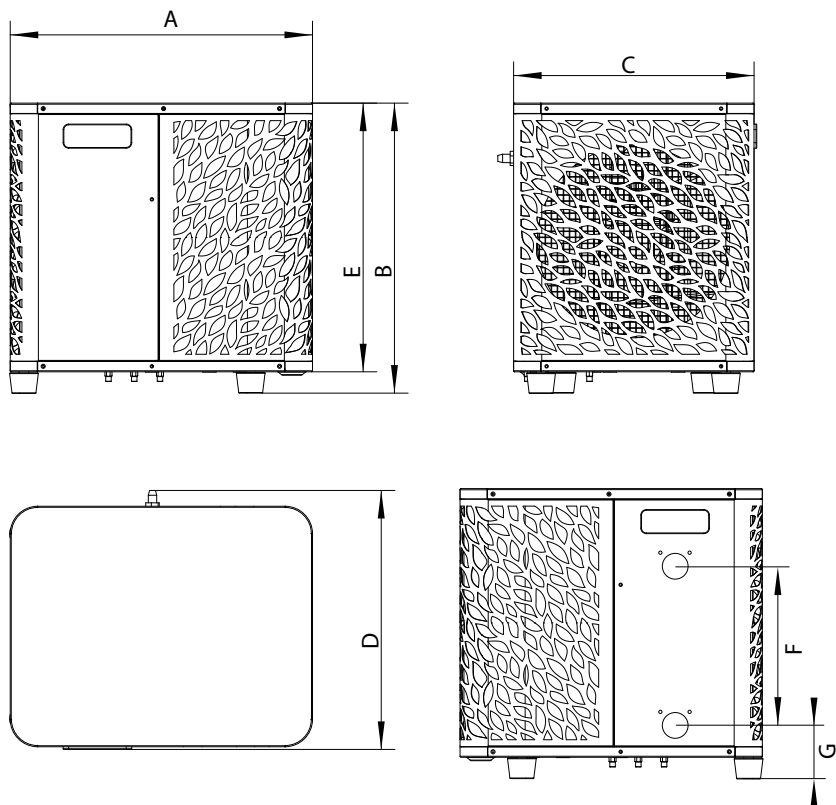

Dimensions in mm

	O'Spa 30	O'Spa 50
A	440	440
B	430	430
C	350	350
D	375	375
E	400	400
F	180	180
G	68.7	68.7

2. Description

2.5 Exploded view

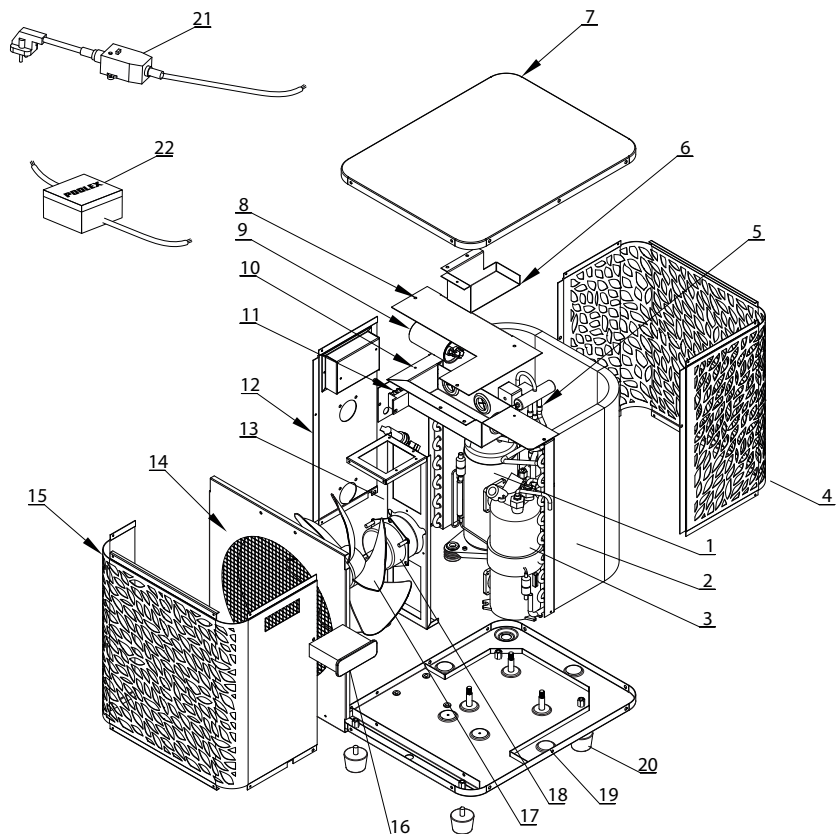

- | | |
|----------------------------|---------------------------------|
| 1. Compressor | 12. Left panel |
| 2. Evaporator | 13. Fan motor mount |
| 3. Heat exchanger | 14. Fan motor protective grille |
| 4. Rear panel | 15. Front panel |
| 5. 4-way valve | 16. Control panel |
| 6. Control panel fix plate | 17. Fan blade |
| 7. Top panel | 18. Fan motor |
| 8. Electrical box cover | 19. Base frame |
| 9. Compressor capacitor | 20. Anti vibration pad |
| 10. Electrical box cover | 21. Cable with RCD 10mA socket |
| 11. Electric connection | 22. SPA heater control relay |

3. Installation

To install the heat pump only the hydraulic circuit and the power need to be connected.

3.1 Location

The heat pump must be installed at least 2.5 m away from the pool.

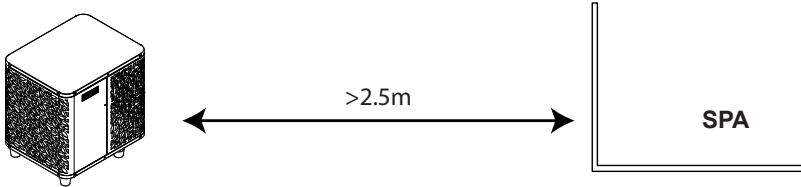

Please respect the following rules when choosing the heat pump's installation location

1. The location must be easily accessible for optimal operation and maintenance.
2. The device must be installed on the ground, ideally on a level concrete slab. Ensure that the ground is sufficiently stable and it can support the weight of the device.
3. Check that there is enough air flow, that the air exhaust is not directed towards the windows of neighbouring buildings, and that exhaust air cannot return to the intake. In addition, ensure that there is enough space around the device to perform servicing and maintenance.
4. The device must not be installed in locations susceptible of being exposed to oil, flammable gas, corrosive agents, sulphur compounds, or near high frequency devices.
5. Do not install the device near to roads or footpaths to avoid mud splattering.
6. To avoid disturbing neighbours, make sure to install the device facing away from areas sensitive to noise.
7. Keep out of the reach of children insofar as possible.

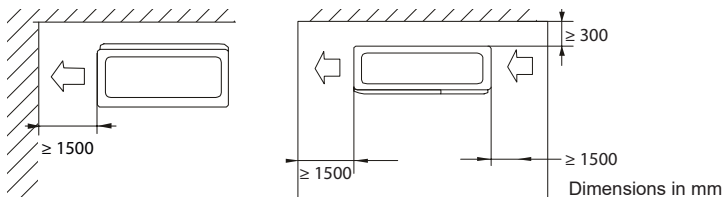

Do not place anything within 1.5m of the front of the heat pump.

Leave at least 30cm of empty space to the sides and rear of the heat pump.

Do not place any obstacles on top or in front of the device!

3. Installation

3.2 Installation diagram

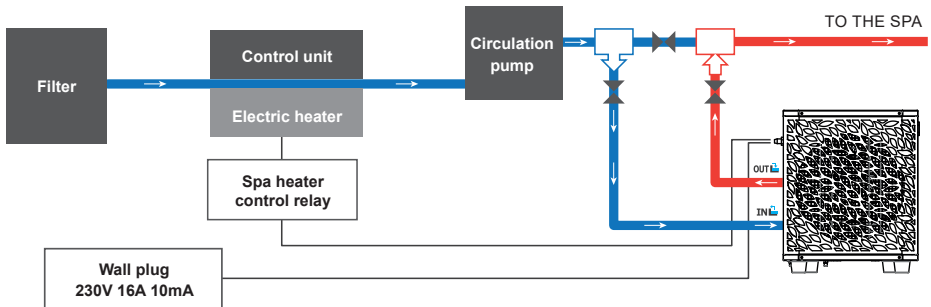

The filter located upstream of the heat pump must be regularly cleared so that the water in the system is clean, thus avoiding the operational problems associated with dirt or clogging in the filter.

3.3 Hydraulic connection

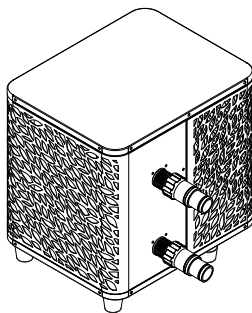

Step 1

Screw the connectors for heat pump

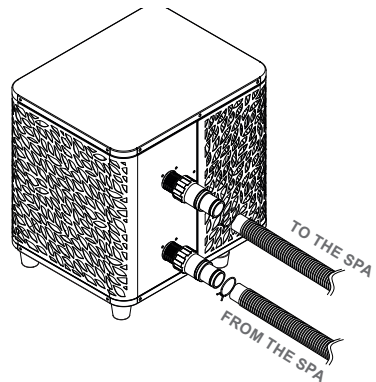

Step 2

Connect the water inlet and outlet

3.4 Electrical connection

Pump's power plug integrates a 10mA differential circuit breaker.

Regularly test the correct operation. In the event of successive triggering or doubts contact the after-sales service.

Before plugging in your heat pump, please ensure the electrical socket is properly grounded and protected from rain as well as water projections.

Press the RESET button to start the O'SPA heat pump. The power indicator lights up in red: the heat pump is on.

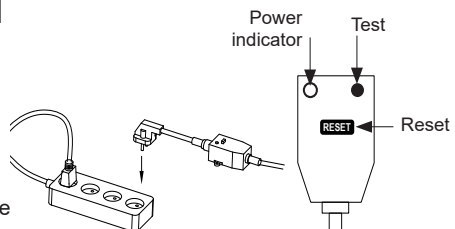

3. Installation

3.5 Operation

Use conditions

For the heat pump to operate normally, the ambient air temperature must be between 10°C and 43°C when it is used alone or between -7°C and 10°C when used with the SPA heater.

Advance notice

Prior to starting the heat pump, please:

- Check that the equipment is in a stable position.
- Check that your electrical installation is in good working condition.
- Check that the hydraulic connections are properly tightened and there is no water leakage.
- Remove any object that is not required around the equipment and all tools.

Operation

1. Connect the power supply to the device.
2. Start the filtration pump.
3. Activate the device's electrical supply protection (differential switch situated on the power cable).
4. Start the heat pump.
5. Select the desired temperature using one of the modes appearing on the control panel.
6. The heat pump's compressor will start shortly after.

And you just need to wait for the target temperature to be reached.



WARNING: Under normal conditions, a suitable heat pump can heat up the tub water by 1°C to 2°C per hour. It is therefore normal that you do not feel any difference in temperature at the outlet level when the heat pump is on.

A heated tub must be covered and insulated to avoid any heat loss.

Good to know: restart after power failure

After a power failure or a usual interruption, turn the power back on, the system is on sleep mode. Restart the differential plus and switch on the heat pump.

4. Use

4.1 Control panel

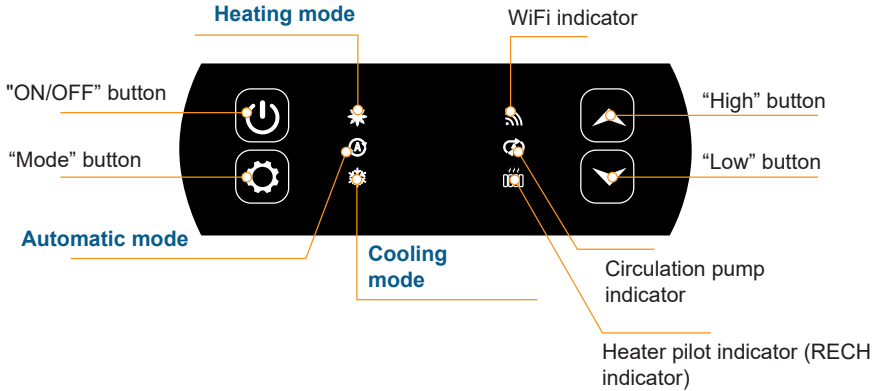

4.2 Heating / Cooling / Automatic mode



Before use, ensure that the filtration pump is working and that water is circulating through the heat pump.

Prior to setting your required temperature, you must first select an operating mode for your remote.



Heating mode

Select the heating mode if you want to heat up the tub water with the heat pump.



Cooling mode

Select the cooling mode if you want to heat up the tub water with the heat pump.



Automatic mode

Select the automatic mode if you want to let the heat pump switch to the correct mode in a smart way according to the target temperature.

4. Use

4.3 Functions overview

The indicators to the right of the control panel indicate the O'SPA heat pump's other functions.



WiFi indicator

Indicates your Wifi connection status. Flashes during pairing (see paragraph 4.9 "Pairing the heat pump"). It remains on when a connection is active.



Circulation pump indicator

On when the circulation pump is active:

- Fixed light in automatic mode,
- Flashing in manual mode.



Heater pilot indicator



The RECH light is on when the heater is active:

- Fixed light in automatic mode,
- Flashing in manual mode.

4.4 Heat pump operating mode selector

By default, the heat pump is in heating mode.

To change the mode of use, when the heat pump is ON:

- Press the button  for 3s, the heat pump will then switch to cooling.
- Press the button again  for 3s, the heat pump will then switch to automatic.
- Press the button again  for 3s, the heat pump will then switch heating.

The different modes thus form a cycle:

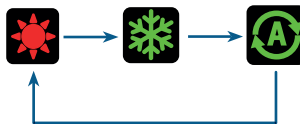

Good to know:

The heat pump can take several minutes to change operating mode in order to preserve the refrigerant fluid.

The maximum set temperature is 40°C.

4. Use

4.5 Using the SPA heater control relay

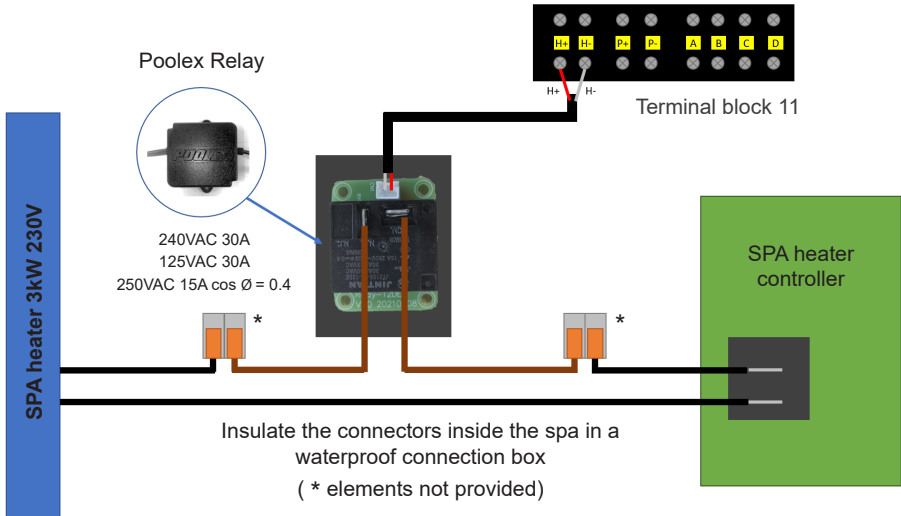

The SPA heater SPAWER driver system consists of a power relay (230V50Hz / 20A) which plugs into the heater phase wire (between the SPA heater controller output and the heater itself).

This relay is controlled by the heat pump control box either automatically or manually (boost).

As such, for the system to work properly, it is imperative to set the desired temperature of the SPA water to the maximum on the SPA control screen (Ex: 38°), so the actual temperature setting will now be done on the heat pump or via the smartphone application.

- **In automatic spa heater mode:** When weather conditions become difficult for the heat pump (C26 setting: outside temperature below 15°C by default; adjustable from 0 to 20°C) and the desired bathing temperature is 5°C higher than the measured water temperature (C27 setting), the heater control relay is triggered. Thus the heating uses the electric heater of the SPA in addition to the heat pump in order to reach the desired temperature.

- **In manual spa heater mode:** Regardless of the weather conditions, as soon as the temperature difference between the set point and the measurement is greater than 2°C (C28 setting), the relay is triggered. Thus the heating uses the electric heater of the SPA in addition to the heat pump in order to reach the desired temperature.

For information, in automatic or cooling mode, the heater control option is inactive, it only operates in heating mode.

To use this relay:

Setting the **C32** setting = 1 to start the control (see advanced settings).

When the heat pump is on heating mode (automatic mode with heatin on): press the  button for 3 seconds to switch the heater from one mode to another (automatic or manual).

In automatic mode, the (RECH) indicator is fixed. In manual mode, the (RECH) indicator flashes.

4. Use

4.6 Using the circulation pump control relay (optional)

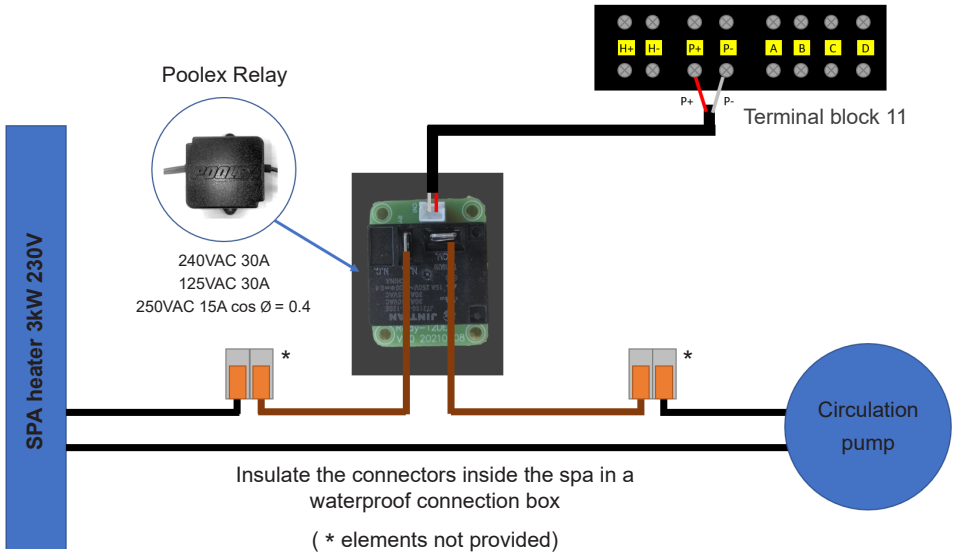

This relay is controlled by the heat pump control box either automatically or manually.

As such, for the system to function correctly, it is imperative to have a circulation pump which minimum flow ranges from 1.2 m³/h to 3 m³/h (to be determined according to the pump selected).

In automatic mode: The relay activates itself every 60 minutes (timing adjustable between 30 and 90 minutes, C31 setting) to control the circulation pump whilst temperature is being verified. If needed, the controller starts the heat pump to reach the target temperature while the pump relay remains active up until the target temperature is reached, then will start its verification cycle every 60 minutes (timing adjustable between 30 and 90 minutes, C31 setting).

In manual mode: The pump relay will always be active and the pump will function 24/7.

To use this relay:

Setting the **C30** setting = 1 to start the control (see advanced settings).

Adjusting verification time intervals, C31 setting, if necessary (adjustable from 30 to 90 minutes).

When the heating pump is switched off (OFF): press on  to switch from the automatic to the manual mode and vice versa.

In automatic mode, the pump indicator is fixed. In manual mode, the pump indicator flashes.

4. Use

4.7 Downloading & installing the application «Smart Life»

About the Smart Life app:

You'll need to create a «Smart Life» account to control your heat pump remotely.

The «Smart Life» app lets you control your home appliances from anywhere. You can add and control multiple devices at once.

- Also compatible with Amazon Echo and Google Home (depending on the country).
- You can share your devices with other Smart Life accounts that you have set up.
- Receive real-time operational alerts.
- Create scenarios with several devices, depending on the app's weather data (geolocation required).

For more information, refer to the "Help" section of the "Smart Life" app.

The "Smart Life" app and services are provided by Hangzhou Tuya Technology. The company Poolstar, owner and distributor of the Poolex brand, cannot be held responsible for the operation of the "Smart Life" application. The company Poolstar has no access to your "Smart Life" account.

iOS :

Scan or search for «Smart Life» in the App Store to download the app:



Check the compatibility of your phone and the version of your OS before installing the application.

Android :

Scan or search for «Smart Life» in the play to download the app:



Check the compatibility of your phone and the version of your OS before installing the application.

4. Use

4.8 Setting up the application



WARNING: Before you begin, make sure you have downloaded the «Smart Life» app, connected to your local WiFi network, and that your heat pump is electrically powered and running.

You'll need to create a «Smart Life» account to control your heat pump remotely. If you already have a Smart Life account, please log in and go directly to step 3.

Step 1: Click on «**Create new account**» and choose to register by «**Email**» or «**Phone**,» where a verification code will be sent to you.

Enter your email address or phone number and click «**Send verification code**».

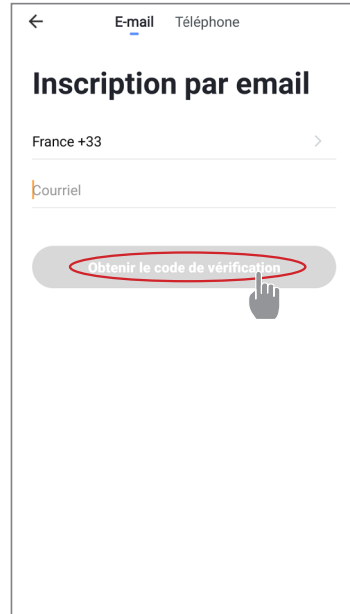
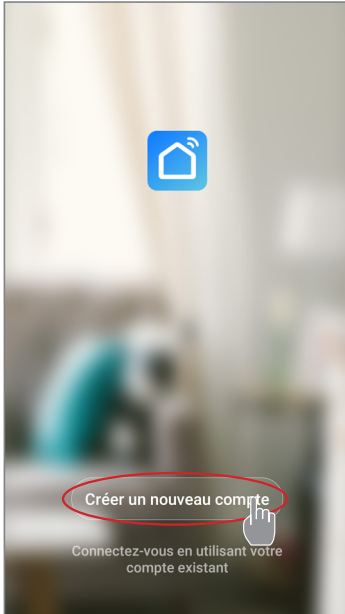

Step 2: Enter the verification code received by email or phone to validate your account.

Congratulations, you now belong to the “Smart Life” community.

4. Use

Step 3 (recommended): Add an object by clicking “...” and then “Add Object”. Enter a name («Pool» for example), then click “Done”.

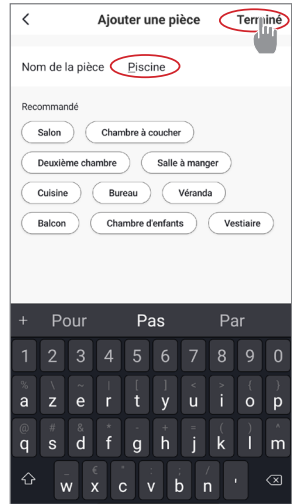
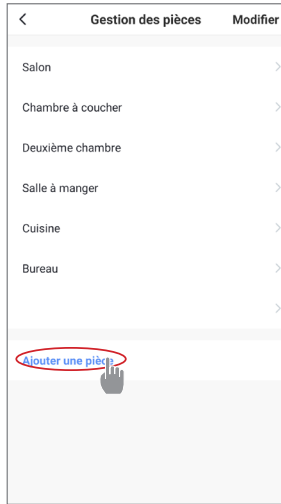
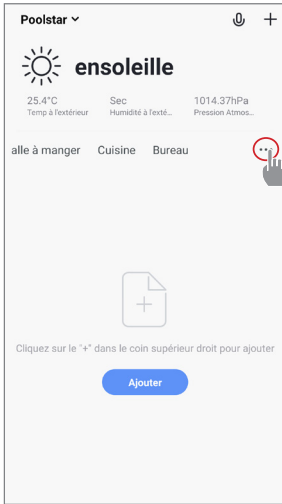

Step 4: Now add a device to your “Pool”.

Click “Add” or “+” and then “Large appliances...” followed by “Water heater”.

At this point, leave your smartphone on the “Add” screen and go to the pairing step for your control box.

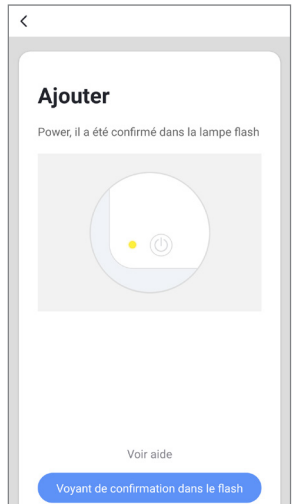
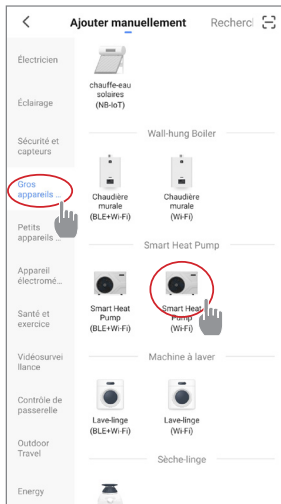
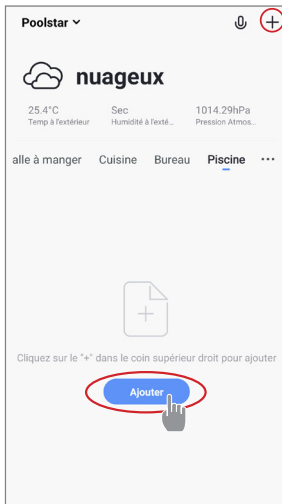

4. Use

4.9 Pairing the heat pump

Step 1: Now start the pairing.

Choose your home WiFi network, enter the WiFi password and press “Confirm”.



WARNING: The «Smart Life» application only supports 2.4Ghz WiFi networks.

If your WiFi network uses the 5GHz frequency, go to the interface of your home WiFi network to create a second 2.4GHz WiFi network (available for most Internet boxes, routers and WiFi access points).

Step 2: Activate the pairing mode on your heat pump according to the following procedure:

The procedure depends on the model of your control panel:



With the heat pump on, press on  for 5 seconds to start the WiFi pairing. The WiFi logo flashes.

The pairing is successful, the “WiFi” logo remains fixed, you can rename your Poolex heat pump then press “Done”.

Congratulations, your heat pump can now be controlled from your smartphone.

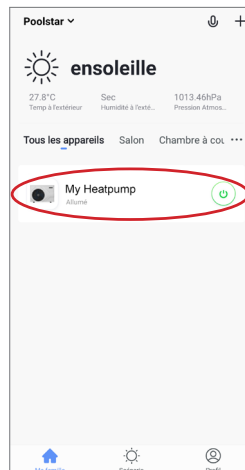
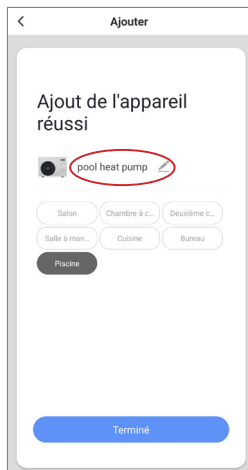

4. Use

4.10 Controlling

User interface

- 1 Current pool temperature
- 2 Temperature set point
- 3 Current operating mode
- 4 Switch the heat pump on/off
- 5 Change the temperature
- 6 Change operating mode
- 7 Set the operating range



Heat pump operating mode selector

You can choose between Auto, Heating or Cooling modes.

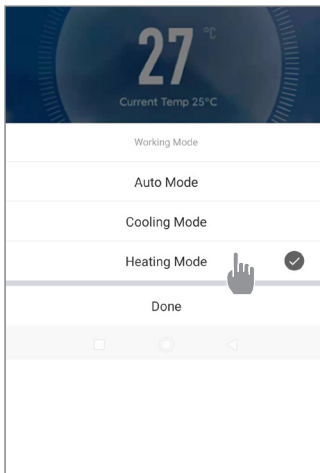

Available modes

Automatic

Cooling

Heating

4. Use

About the settings

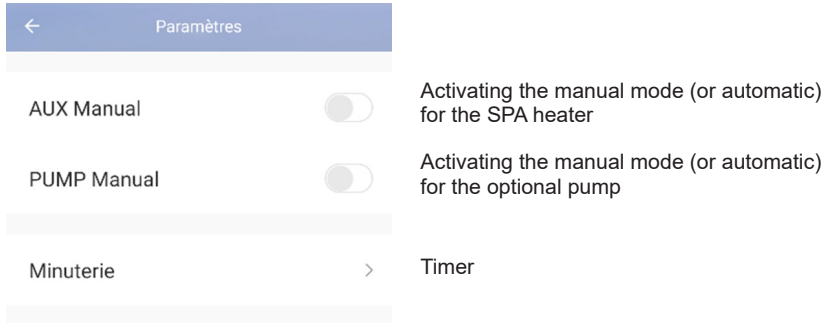

Setting up the heat pump operating range

Step 1: Create a time schedule, choose the time, the day(s) of the week concerned, and the action (switch on or switch off), then save.

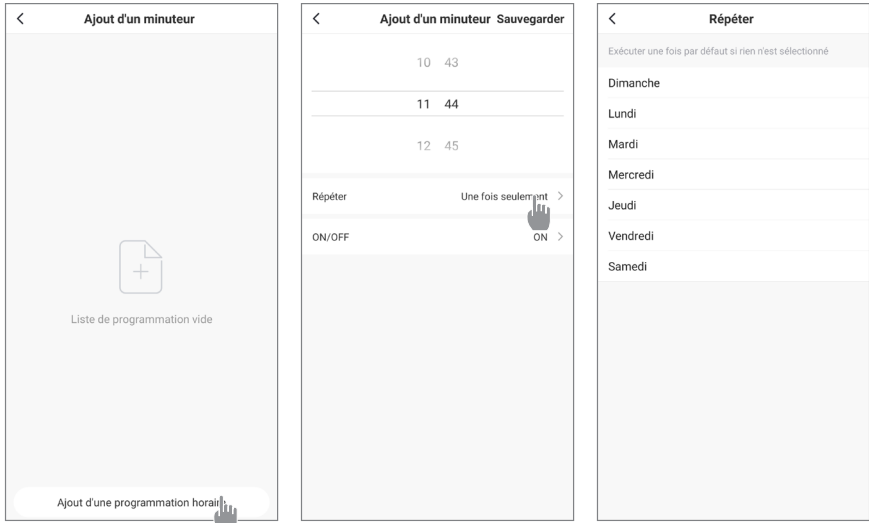

Step 2: To delete a time slot, press and hold the time slot.

4. Use

4.11 Status values

The system's settings can be checked and adjusted via the remote control by following these steps

Step 1: Press on  until you enter the settings verification mode.

Step 2: Press on  and  to see the parameters.

Step 3: Press on  to select the setting to be viewed.

Parameters table

<i>Parameters</i>	<i>Indication</i>	<i>Adjustment range</i>	<i>Comments</i>
<i>D0</i>	<i>Ambient temperature</i>	<i>-20°C- 80°C</i>	<i>Measured value</i>
<i>D1</i>	<i>Inlet water temperature</i>	<i>-20°C- 80°C</i>	<i>Measured value</i>
<i>D2</i>	<i>Outlet water temperature</i>	<i>-20°C- 140°C</i>	<i>Measured value</i>
<i>D3</i>	<i>Coil temperature</i>	<i>-20°C- 80°C</i>	<i>Measured value</i>
<i>D4</i>	<i>Compressor</i>	<i>ON/OFF</i>	<i>Measured value</i>
<i>D5</i>	<i>Ventilator</i>	<i>ON/OFF</i>	<i>Measured value</i>
<i>D6</i>	<i>4-way valve</i>	<i>ON/OFF</i>	<i>Measured value</i>
<i>D7</i>	<i>High pressure protection</i>	<i>--</i>	
<i>D8</i>	<i>Low pressure protection</i>	<i>ON/OFF</i>	<i>Measured value</i>
<i>D9</i>	<i>Flow sensor</i>	<i>--</i>	

4. Use

4.12 Advanced settings



WARNING: This operation is used to assist servicing and future repairs.

The default settings should only be modified by an experienced professional person.

The system's settings can be checked and adjusted via the remote control by following these steps

Caution, some settings cannot be modified, check the settings table for more information.

Step 1: Switch off the heat pump.

Step 2: Keep pressing  for 3 seconds to access the settings.

Step 3: Select the desired setting using the down and up arrows

Step 4: Press on  to select the setting to be adjusted.

Step 5: Press on  to save the new value.

Parameters	Indication	Adjustment range	Default v.	Comments
C0	Setting inlet water temp in heating mode	15°C~40°C	38°C	adjustable
C1	Water temp difference for restart in heating mode	1°C~10°C	3°C	adjustable
C2	Auto restart(0-without, 1-with)	0-1	1	adjustable
C3	Protection setting for too high discharge temp	30°C~120°C	110°C	adjustable
C4	Max. inlet water setting temp in heating mode	30°C~60°C	40°C	adjustable
C5	Min. inlet water setting temp in heating mode	5°C~30°C	15°C	adjustable
C6	Difference water temp to stop in heating mode	0°C~18°C	0	adjustable
C7	Setting inlet water temp in cooling mode	7°C~30°C	26°C	adjustable
C8	Water temp difference for restart in heating mode	0°C~18°C	3°C	adjustable
C9	Difference water temp to stop in cooling mode	0°C~18°C	0	adjustable
C10	Max. inlet water setting temp in cooling mode	20°C~35°C	30°C	adjustable
C11	Min. inlet water setting temp in cooling mode	2°C~18°C	7°C	adjustable
C12	Protection setting for too low ambient temp	-25~20°C	-7°C*	adjustable
C13	Protection setting for too high ambient temp	35~60°C	42°C	adjustable
C14	Protection temp difference for ambient temp	1~10°C	1°C	adjustable
C26	AUX turn On ambient temp in heater Auto mode	0°C ~ 20°C	15	adjustable
C27	AUX water temp difference for restart in heater Auto mode	1~5°C	5	adjustable
C28	AUX water temp difference for restart in Manual mode	1~5°C	2	adjustable
C29	Setting inlet water temp in Auto mode	7°C~40°C	38°C	adjustable
C30	PUMP parameter	0 (deactivated) /1 (activated)	0	adjustable
C31	PUMP working interval of time	30-90 min	60 min	adjustable
C32	AUX parameter	0 (deactivated) /1 (activated)	1	adjustable
H0	Defrosting mode activation timer	1~240min	45 min	adjustable
H1	Defrosting mode max. duration	1~25min	8 min	adjustable
H2	Defrosting exit coil temp	1~25°C	12°C	adjustable
H3	Defrosting entry coil temp	-20~20°C	-1°C	adjustable
H4	Temp difference between defrosting entry ambient temp and coil temp	0~15°C	5°C	adjustable
H5	Min. Ambient temp to entry defrosting	0~20°C	20°C	adjustable
P1	CN6 function selection	0 : no function 1 : high pressure switch (reserved) 2 : water flow switch (reserved) 3 : in.grip function	3	

When OFF, pressing on  for 5 seconds resets the settings to factory settings.

5. Maintenance and servicing

5.1 Maintenance, servicing and winterizing



WARNING: Before undertaking maintenance work on the unit, ensure that you have disconnected the electrical power supply.

Cleaning

The heat pump housing must be cleaned with a damp cloth. Using detergents or other household cleaning products may degrade the surface of the housing and affect its integrity.

The evaporator at the rear of the heat pump must be carefully cleaned with a vacuum cleaner and soft brush attachment.

Annual maintenance

The following operations must be undertaken by a qualified person at least once a year.

- Carry out safety checks.

- Check the integrity of the electrical wiring.

- Check the earthing connections.

Wintering

Your heat pump is designed to operate in all weather. However, if you winterize your SPA, it is not recommended to leave the heat pump outside for long periods of time (eg over winter). After draining down the SPA for the winter, uninstall the heat pump and store it in a dry place.

6. Repairs



WARNING: Under normal conditions, a suitable heat pump can heat up the tub water by 1°C to 2°C per hour. It is therefore normal that you do not feel any difference in temperature at the outlet level when the heat pump is on.

A heated tub must be covered and insulated to avoid any heat loss.

6.1 Breakdown and faults

In the event of a problem, the heat pump's screen displays an error code instead of temperature indications. Please consult the table below to find the possible causes of a fault and the actions to be taken.

Code	Fault Name	Action
E00	Ambient temp too high or too low Température de l'air trop chaude ou trop froide	Shutdown protection
E01	Inlet water temp sensor failure Défaut du capteur de température d'entrée	Shutdown protection
E02	Ambient temp sensor failure Défaut du capteur de température ambiante	Shutdown protection
E03	Too high discharge gas temp Température de gaz trop élevée	Shutdown protection
E04	Discharge temp sensor failure Défaut du capteur de température de refoulement	Shutdown protection
E05	Coil temp sensor failure Défaut du capteur de température de la bobine	Shutdown protection
EL	Low pressure protection Protection basse pression	Shutdown protection
EH	High pressure protection Protection haute pression	Shutdown protection
E06	Water flow protection Protection contre le débit d'eau	Shutdown protection

7. Warranty

7.1 General terms and conditions of delivery

Poolstar guarantees the original owner against material defects and manufacturing defects of Poolx heat pump O'Spa for a period of two **(2) years**.

The warranty enters into force on the first billing date.

This warranty does not apply to the following situations:

- Malfunction or damage resulting from installation, use or repair that does not comply with the safety instructions.
- Malfunction or damage deriving from an unsuitable chemical environment of the swimming pool.
- Malfunction or damage resulting from conditions unsuitable for the intended use of the device.
- Damage resulting from negligence, accident, or force majeure.
- Malfunction or damage deriving from the use of unauthorized accessories.

Repairs undertaken during the warranty period must be approved before being carried out by a qualified technician. This warranty is void in the event of repairs to the device made by individuals which have not been authorised by Poolstar.

The parts under warranty shall be replaced or repaired at the discretion of Poolstar. Faulty parts must be returned to us during the warranty period in order to be covered. The warranty does not cover unauthorized labor or replacement costs. Delivery costs for returning the faulty part are not covered by the warranty.

Dear customer,

A question? A problem? Or simply register your

warranty, find us on our website:

<https://assistance.poolstar.fr/>

Thank you for your trust and support. Happy bathing!

Your personal information is processed in accordance with the French Data Protection Act of 06 January 1978 and will not be shared with 3rd parties.

POOLEX

0' SPA

TECHNICAL ASSISTANCE

www.poolex.fr